

Main unit

| | | | |
|--|---|---|---|
| Power supply | | AC100-240V, 50Hz/60Hz | |
| Power consumption ¹ | Maximum power consumption | | 325 W (3.4A-1.4A) [330VA] (The power consumption is 310 W at 200-240V) |
| | On-mode power consumption (Light power) | [NORMAL] | 290 W (100-240V), 275 W (200-240V) |
| | | [ECO] | 220 W (100-240V), 210 W (200-240V) |
| | | [QUIET1] | 250 W (100-240V), 240 W (200-240V) |
| | | [QUIET2] | 215 W (100-240V), 205 W (200-240V) |
| Standby mode power consumption | [NORMAL] | 15 W | |
| | [ECO] | 0.5 W | |
| BTU value | | Max 1110 BTU | |
| LCD panel | Size | | 1.63 cm [0.64 in] diagonal (16:10 aspect ratio) |
| | Display system | | Transparent LCD panel (x 3, R/G/B) |
| | Number of pixels | | 2,304,000 pixels (1920 x 1200 dots) when [QUAD PIXEL DRIVE] is set to [OFF] 9,216,000 pixels (3840 x 2400 dots) when [QUAD PIXEL DRIVE] is set to [ON] |
| | Colors | | Approx. 1,073 Million Colors (The maximum number of display colors varies depending on the signal.) |
| Refresh rate | | 240 Hz (Refresh rate varies depending on scanning frequency.) | |
| Light source | | Laser Diode | |
| Light output ^{2,3} | Light Power | [NORMAL] | 6,500 lm |
| | | [ECO] | 4,550 lm |
| | | [QUIET1] | 5,500 lm |
| | | [QUIET2] | 4,550 lm |
| Time until light output declines to 50% ⁴ | Light Power | [NORMAL] | 20,000 hours |
| | | [ECO] | 24,000 hours |
| | | [QUIET1]/ [QUIET2] | 20,000 hours |
| Filter Replacement Cycle | | 20,000 hours (Under the dust conditions of 0.08 mg/m ³) 10,000 hours (Under the dust conditions of 0.15 mg/m ³) Filter cleaning cycle varies depending on the environment. The filter can be washed and reused up to two times. | |
| Resolution | | 3840 x 2400 pixels (achieved with 2-axis pixel-shifting technology) | |
| Contrast ratio ¹ | | 5,000,000:1 (All White/All Black) When [PICTURE MODE] is set to [DYNAMIC], [DYNAMIC CONTRAST] is set to [1] | |
| Screen size | | 0.76-7.62 m [30-300 in], 16:10 aspect ratio | |
| Center to corner zone ratio ¹ | | 85% | |
| Lens | | 1.6x Manual zoom (Optical) (Throw ratio 1.09-1.77:1) Manual focus lens, F=1.58-1.91, f=15.30-24.60 mm | |
| Digital Zoom Extender ⁵ | | Throw Ratio 1.09-2.21:1 (Converted value) (When optical zoom is used together.) | |
| Lens shift (from the origin point of the lens mounter) | Vertical | +44% | |
| | Horizontal | ±20% | |
| Installation | | Ceiling/floor, front/rear, free 360-degree installation | |
| Maximum usable volume output | | 10W (monaural) | |
| Compatible Signal | HDMI™ signal input | Video signal resolution: 480/60p, 576/50p to 4096 x 2160/60p Computer signal resolution: 640 x 480 to 3840x2400 (non-interlace) Dot clock frequency: 25.2 MHz to 594 MHz | |
| | DIGITAL LINK signal input | Video signal resolution: 480/60p, 576/50p to 4096 x 2160/60p Computer signal resolution: 640 x 480 to 3840x2400 (non-interlace) Dot clock frequency: 25.2 MHz to 297 MHz | |
| Terminals | <HDMI™ IN 1> <HDMI™ IN 2> | HDMI™ x 2, HDCP 2.3 compatible, Deep Color compatible, CEC supported Audio signal Linear PCM (sampling frequency: 48 kHz/44.1 kHz/32 kHz) | |
| | <HDMI™ OUT> | HDMI™ x 1, CEC not supported | |
| | <DIGITAL LINK/LAN> | RJ-45 x 1, for network and DIGITAL LINK connections (HDBaseT™ compliant), PJLink™ (class 2) compatible, 100Base-TX, HDCP compatible, Deep Color compatible | |
| | <LAN> | RJ-45 x 1, for network connection, PJLink™ (class 2) compatible, 10Base-T/100Base-TX | |

| | | |
|-------------------------------------|--|--|
| Terminals | <AUDIO IN> | M3 stereo mini jack x 1, 0.5V [rms], input impedance 22 kΩ or more |
| | <AUDIO OUT> | M3 stereo mini jack x 1, monitor output and stereo compatible, 0 V [rms] to 2.0 V [rms] (variable), output impedance 2.2 kΩ or lower |
| | <USB (VIEWER/WIRELESS/DC OUT)> | USB connector (type A) x 1, for Memory Viewer function/ Wireless module (Model No.: AJ-WM50 Series) connection/power supply (DC 5V, maximum 2A) |
| | <SERIAL IN> | D-Sub 9 p x 1, RS-232C compliant, for computer control |
| Supported Internet protocol version | | IPv4, IPv6 ⁵ |
| Power cord length | | 2.0 m [6 ft 7 in] (3.0 m [9 ft 10 in] for India) |
| Cabinet materials | | Molded plastic |
| Dimensions ⁷ | Width | 399 mm [15 23/32 in] (excluding protrusions) |
| | | 399 mm [15 23/32 in] (including protrusions) |
| | Height | 115 mm [4 17/32 in] (excluding feet, protrusions) |
| | | 133 mm [5 1/4 in] (with the feet at shortest position, including protrusions) |
| Depth | 348 mm [13 11/16 in] (excluding protrusions) | |
| | 348 mm [13 11/16 in] (including protrusions) | |
| Weight ⁸ | | 6.9 kg (15.2 lbs) |
| Operating noise ¹ | [NORMAL] | 35 dB |
| | [ECO] | 35 dB |
| | [QUIET1] | 30 dB |
| | [QUIET2] | 25 dB |
| Laser Classification | Laser Class | Class 1 (IEC/EN 60825-1:2014) |
| | Risk Group | Risk Group 2 (IEC 62471-5:2015) |
| Operating environment | Operating environment temperature | 0°C (32°F) to 45°C (113°F) ⁹ *The operating environment temperature should be between 0°C (32°F) and 40°C (104°F) when the optional Wireless Module (Model No.: AJ-WM50 Series) is attached. |
| | Operating environment humidity | 20% to 80% (no condensation) |

Remote control unit

| | | |
|---------------------|--------|--|
| Power supply | | 3V DC (AAA/R03/LR03 battery x 2) |
| Operation range | | Approx. 30 m [98 ft 5 in] (when operated directly in front of signal receptor) |
| Dimensions | Width | 48 mm [1 7/8 in] |
| | Height | 145 mm [5 23/32 in] |
| | Depth | 27 mm [1 1/16 in] |
| Weight ⁸ | | Approx. 102 g (3.60 ozs.) including batteries |

Supplied accessories

- Power cord (x 2 for Europe and Asia model/ x 1 for other countries)
- Wireless remote control unit (x 1)
- Batteries for remote control (R03/AAA type x 2)

Other Applications

- Multi Monitoring and Control Software (for Windows)
- Wireless Projector App (for iOS/Android™)
- Projector Network Setup Software (for Windows)

Optional accessories

| | | |
|--|-------------------------|--|
| Ceiling Mount Bracket | for high ceilings | ET-PKL100H |
| | for low ceilings | ET-PKL100S |
| | Projector Mount Bracket | ET-PKV400B |
| Replacement Filter Unit | | ET-RFV500 |
| Media Processor | | ET-FMP50/ET-FMP20 |
| Wireless Module | | AJ-WM50 Note: The suffix at the end of the model number is omitted. Operating Temperature when attached to the projector: 0-40°C (32-104°F). |
| Wireless Presentation System (PressIT) | | TY-WPS2 (basic set) Note: For further details, please visit the following website: https://docs.connect.panasonic.com/prodisplays/products/ty-wps2/ |

Weights and dimensions shown are approximate. Specifications subject to change without notice.

- 1 Measurement, measuring conditions, and method of notation all comply with ISO/IEC 21118:2020 international standards. Value is the average of all products when shipped.
- 2 Measurement, measuring conditions, and method of notation all comply with American National Standards Institute standards. Value is the average of all products when shipped.
- 3 When [PICTURE MODE] is set to [DYNAMIC], [LIGHT POWER] is set to [NORMAL], [DAYLIGHT VIEW] is set to [OFF], [AUTO POWER SAVE] is set to [OFF].
- 4 Around this time, light output will have decreased by approximately 50%. IEC62087: 2008 Broadcast contents, Dynamic Contrast [2], under conditions with 30°C (86°F), 700m (2,297ft) above sea level, and 0.15 mg/m³ of particulate matter. Panasonic recommends cleaning or checkup at point of purchase after about 20,000 hours. Light-source lifetime may be reduced depending on environmental conditions.
Replacement of parts other than the light source may be required in a shorter period. Estimated maintenance time varies depending on environment.
- 5 Resolution decreases when using this function. 6-Point Screen Correction, V/H Keystone Correction, and curved-screen correction are not available when using this function, and range of corner adjustment is limited.
- 6 Optional wireless module AJ-WM50 Series only supports IPv4.
- 7 With legs at shortest position.
- 8 Average value. May differ depending on the actual unit.
- 9 Note that projector cannot be used at altitudes 2,700m (8,858ft) or higher above sea level. In the following operating environments, light output may be reduced to protect the projector; when the projector is used at altitudes below 700m (2,297ft) and ambient temperature is 36°C (97°F) or higher; when the projector is used at altitudes between 700m (2,297ft) and 1,400m (4,593ft) exclusive and ambient temperature is 34°C (93°F) or higher; when the projector is used at altitudes between 1,400m (4,593ft) and 2,100m (6,890ft) exclusive and ambient temperature is 32°C (90°F) or higher; and when the projector is used at altitudes between 2,100m (6,890ft) and 2,700 m (8,858ft) exclusive and ambient temperature is 30°C (86°F) or higher.

Terminals

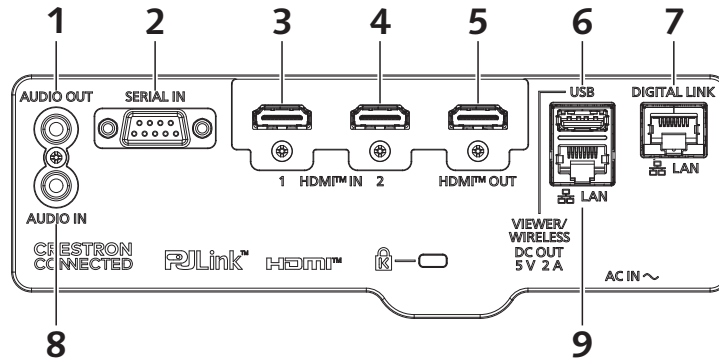

| | | | |
|---|--------------|---|--------------------------------|
| 1 | <AUDIO OUT> | 6 | <USB (VIEWER/WIRELESS/DC OUT)> |
| 2 | <SERIAL IN> | 7 | <DIGITAL LINK/LAN> |
| 3 | <HDMI™ IN 1> | 8 | <AUDIO IN> |
| 4 | <HDMI™ IN 2> | 9 | <LAN> |
| 5 | <HDMI™ OUT> | | |

Dimensions

unit : mm [inch]
 NOTE: This illustration is not drawn to scale.

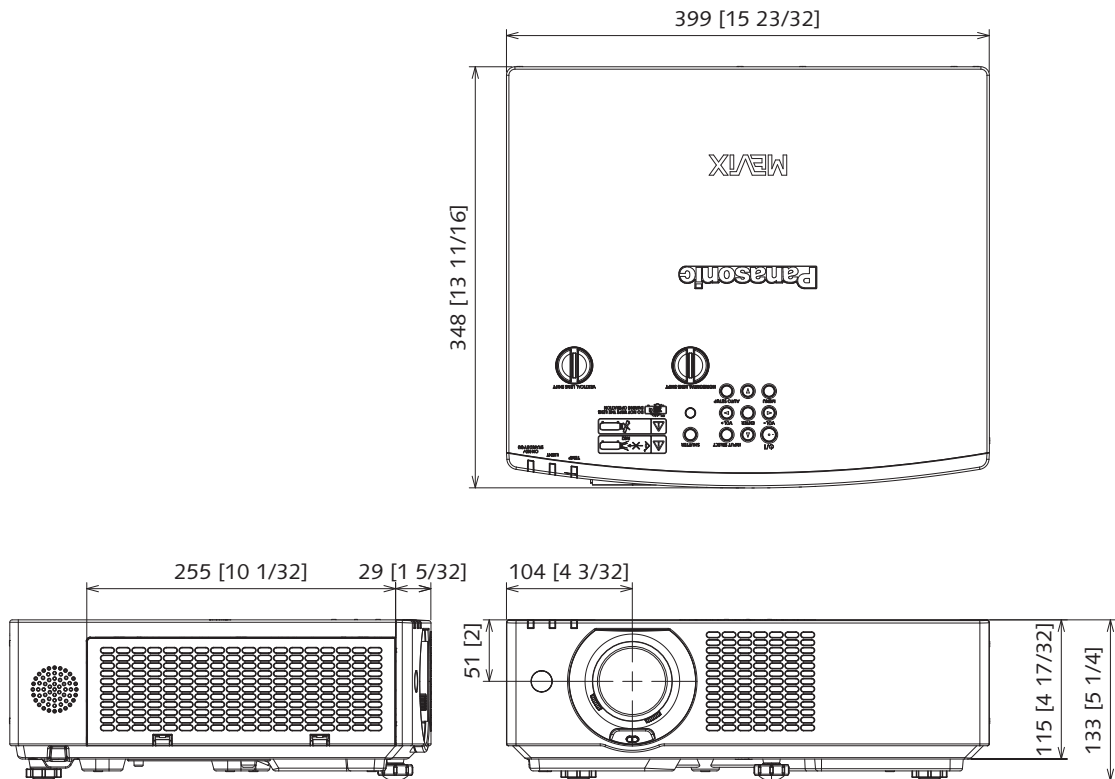

Projected image and throw distance

Install the projector referring to the projected image size and projection distance. Image size and image position can be adjusted in accordance with the screen size and screen position.

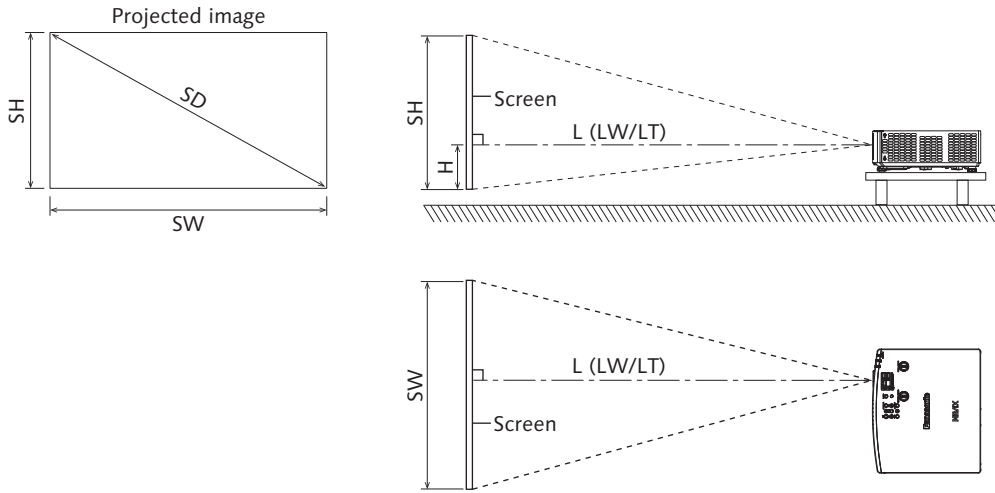

Note

- This illustration is prepared on the assumption that the projected image size and position have been aligned to fit full in the screen.
- This illustration is not drawn to scale.
- The values are approximate.

| | | |
|----|----|---|
| L | | Projection distance |
| | LW | Minimum distance |
| | LT | Maximum distance |
| SH | | Projected image height |
| SW | | Projected image width |
| H | | Distance from the center of lens to the image lower end |
| SD | | Projected image size |

Standard setting position

Illustrations show the projector installed using optional ceiling mount bracket ET-PKL100H and projector mount bracket ET-PKV400B.

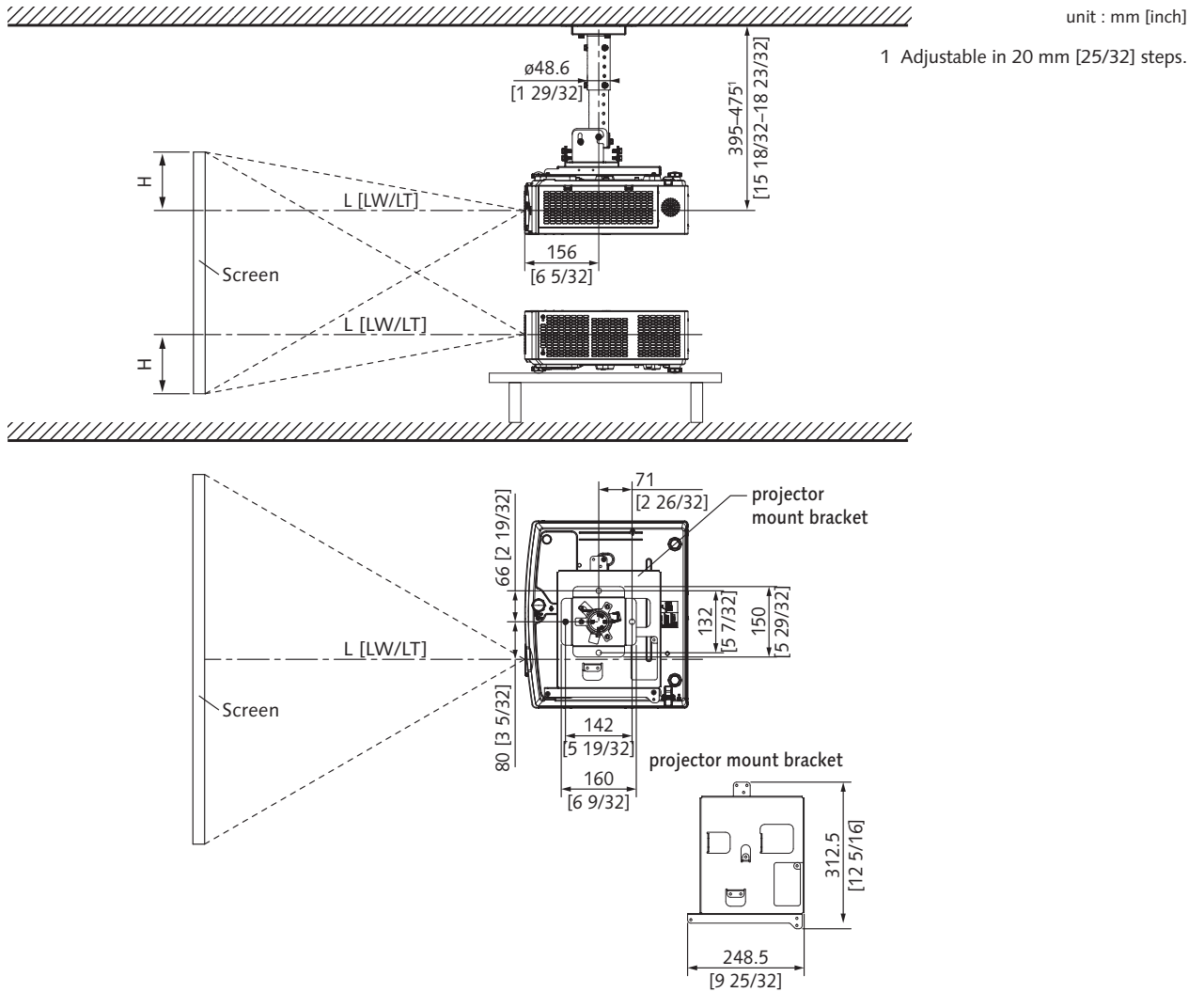

Caution

- All construction work should be done by a qualified technician.
- When mounting to the ceiling, use the special mounting bracket.
Furthermore, in order to prevent it from falling down from the ceiling, use the supplied wire on the mounting bracket.

Note

- This illustration is prepared on the assumption that the projected image size and position have been aligned to fit full in the screen.
- This illustration is not drawn to scale.
- The values are approximate.

Illustrations show the projector installed using optional ceiling mount bracket ET-PKL100S and projector mount bracket ET-PKV400B.

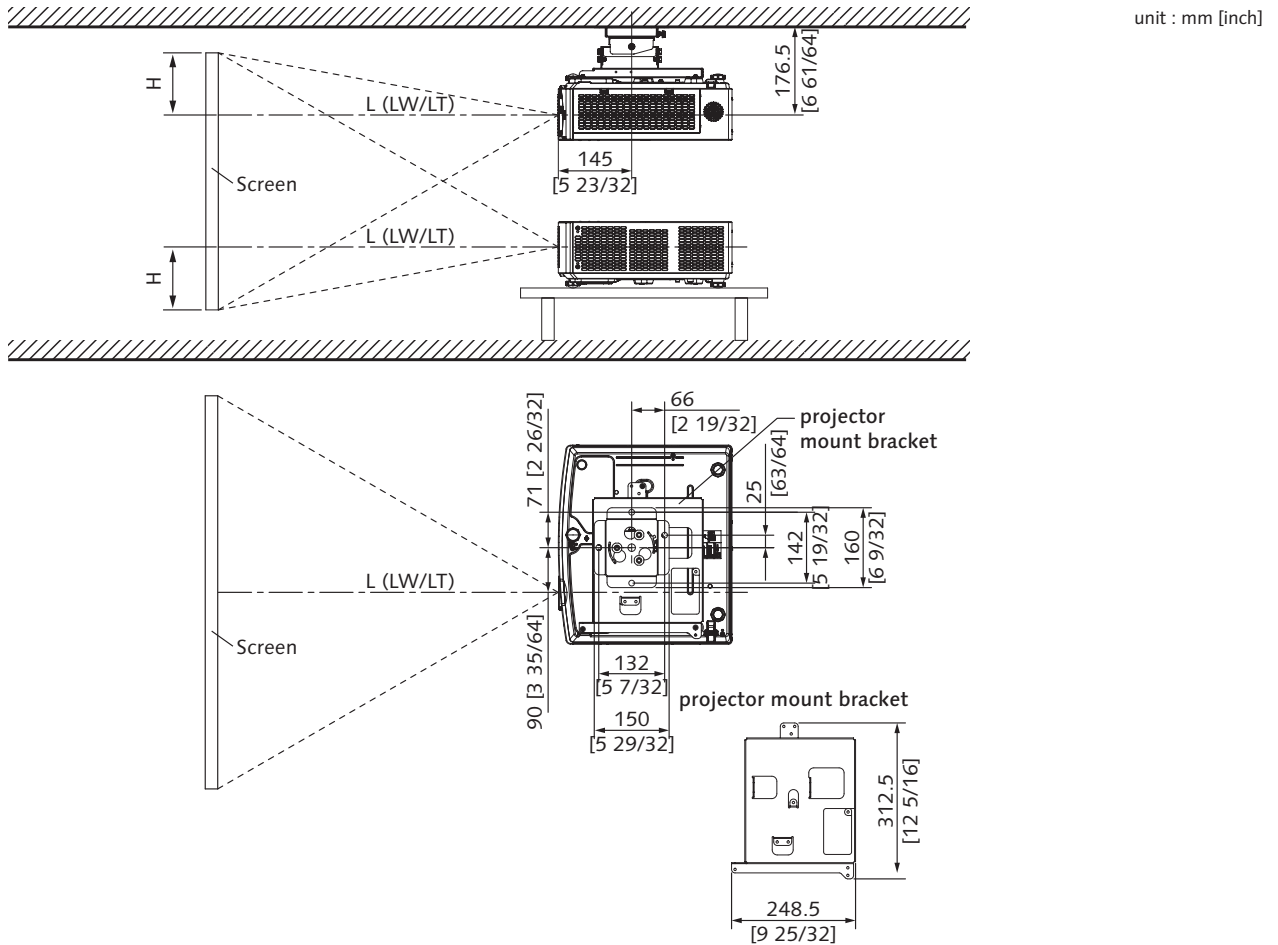

Caution

- All construction work should be done by a qualified technician.
- When mounting to the ceiling, use the special mounting bracket.
Furthermore, in order to prevent it from falling down from the ceiling, use the supplied wire on the mounting bracket.

Note

- This illustration is prepared on the assumption that the projected image size and position have been aligned to fit full in the screen.
- This illustration is not drawn to scale.
- The values are approximate.

Projection distance

A ±5 % error in listed projection distances may occur. When [SCREEN ADJUSTMENT] is used, distance is corrected to become smaller than the specified image size.

Screen aspect ratio 16:10

Unit: meters

| Throw ratio | | | | Optical zoom | | Digital Zoom Extender ¹ | Distance from the center of lens to the image lower end (H) ³ |
|----------------------|--------|-------------|------------|--|-----------|------------------------------------|--|
| Projected image size | | | | Projection distance (L) | | | |
| Diagonal (SD) | | Height (SH) | Width (SW) | Min. (LW) | Max. (LT) | Max. (LT) | |
| m | inches | | | | | | |
| 1.09-1.77:1 | | | | 1.09-2.21:1 ² (Converted Value) | | | |
| 0.76 | 30 | 0.40 | 0.64 | 0.68 | 1.12 | 1.40 | 0.022 - 0.201 |
| 1.02 | 40 | 0.54 | 0.86 | 0.93 | 1.51 | 1.89 | 0.030 - 0.270 |
| 1.27 | 50 | 0.67 | 1.08 | 1.16 | 1.89 | 2.37 | 0.037 - 0.337 |
| 1.52 | 60 | 0.81 | 1.29 | 1.39 | 2.26 | 2.84 | 0.045 - 0.403 |
| 1.78 | 70 | 0.94 | 1.51 | 1.64 | 2.66 | 3.33 | 0.052 - 0.472 |
| 2.03 | 80 | 1.08 | 1.72 | 1.87 | 3.03 | 3.80 | 0.060 - 0.538 |
| 2.29 | 90 | 1.21 | 1.94 | 2.12 | 3.43 | 4.29 | 0.067 - 0.607 |
| 2.54 | 100 | 1.35 | 2.15 | 2.35 | 3.80 | 4.76 | 0.075 - 0.673 |
| 3.05 | 120 | 1.62 | 2.59 | 2.83 | 4.57 | 5.73 | 0.090 - 0.808 |
| 3.81 | 150 | 2.02 | 3.23 | 3.54 | 5.72 | 7.16 | 0.112 - 1.010 |
| 5.08 | 200 | 2.69 | 4.31 | 4.73 | 7.64 | 9.56 | 0.150 - 1.346 |
| 6.35 | 250 | 3.37 | 5.38 | 5.92 | 9.56 | 11.96 | 0.187 - 1.683 |
| 7.62 | 300 | 4.04 | 6.46 | 7.11 | 11.48 | 14.35 | 0.224 - 2.019 |

- 1 When optical zoom and Digital Zoom Extender are used together.
- 2 When [EXTENDER RATIO] is set to [80%].
- 3 Only for optical zoom

Unit: feet

| Throw ratio | | | | Optical zoom | | Digital Zoom Extender ¹ | Distance from the center of lens to the image lower end (H) ³ |
|----------------------|--------|-------------|------------|--|-----------|------------------------------------|--|
| Projected image size | | | | Projection distance (L) | | | |
| Diagonal (SD) | | Height (SH) | Width (SW) | Min. (LW) | Max. (LT) | Max. (LT) | |
| m | inches | | | | | | |
| 1.09-1.77:1 | | | | 1.09-2.21:1 ² (Converted Value) | | | |
| 0.76 | 30 | 1.31 | 2.10 | 2.23 | 3.67 | 4.59 | 0.072 - 0.659 |
| 1.02 | 40 | 1.77 | 2.82 | 3.05 | 4.95 | 6.20 | 0.098 - 0.886 |
| 1.27 | 50 | 2.20 | 3.54 | 3.81 | 6.20 | 7.78 | 0.121 - 1.106 |
| 1.52 | 60 | 2.66 | 4.23 | 4.56 | 7.41 | 9.32 | 0.148 - 1.322 |
| 1.78 | 70 | 3.08 | 4.95 | 5.38 | 8.73 | 10.93 | 0.171 - 1.549 |
| 2.03 | 80 | 3.54 | 5.64 | 6.14 | 9.94 | 12.47 | 0.197 - 1.765 |
| 2.29 | 90 | 3.97 | 6.36 | 6.96 | 11.25 | 14.07 | 0.220 - 1.991 |
| 2.54 | 100 | 4.43 | 7.05 | 7.71 | 12.47 | 15.62 | 0.246 - 2.208 |
| 3.05 | 120 | 5.31 | 8.50 | 9.28 | 14.99 | 18.80 | 0.295 - 2.651 |
| 3.81 | 150 | 6.63 | 10.60 | 11.61 | 18.77 | 23.49 | 0.367 - 3.314 |
| 5.08 | 200 | 8.83 | 14.14 | 15.52 | 25.07 | 31.36 | 0.492 - 4.416 |
| 6.35 | 250 | 11.06 | 17.65 | 19.42 | 31.36 | 39.24 | 0.614 - 5.522 |
| 7.62 | 300 | 13.25 | 21.19 | 23.33 | 37.66 | 47.08 | 0.735 - 6.624 |

- 1 When optical zoom and Digital Zoom Extender are used together.
- 2 When [EXTENDER RATIO] is set to [80%].
- 3 Only for optical zoom

Screen aspect ratio 16:9

Unit: meters

| | | | | Optical zoom | | Digital Zoom Extender ¹ | Distance from the center of lens to the image lower end (H) ³ |
|----------------------|--------|-------------|------------|-------------------------|-----------|--|--|
| Throw ratio | | | | 1.09-1.77:1 | | 1.09-2.21:1 ² (Converted Value) | |
| Projected image size | | | | Projection distance (L) | | | |
| Diagonal (SD) | | Height (SH) | Width (SW) | Min. (LW) | Max. (LT) | Max. (LT) | |
| m | inches | | | | | | |
| 0.76 | 30 | 0.37 | 0.66 | 0.70 | 1.15 | 1.44 | 0.002 - 0.186 |
| 1.02 | 40 | 0.50 | 0.89 | 0.95 | 1.55 | 1.95 | 0.003 - 0.250 |
| 1.27 | 50 | 0.62 | 1.11 | 1.19 | 1.94 | 2.43 | 0.004 - 0.311 |
| 1.52 | 60 | 0.74 | 1.33 | 1.43 | 2.33 | 2.92 | 0.005 - 0.372 |
| 1.78 | 70 | 0.87 | 1.55 | 1.69 | 2.73 | 3.42 | 0.005 - 0.436 |
| 2.03 | 80 | 0.99 | 1.77 | 1.93 | 3.12 | 3.91 | 0.006 - 0.497 |
| 2.29 | 90 | 1.12 | 2.00 | 2.18 | 3.52 | 4.41 | 0.007 - 0.561 |
| 2.54 | 100 | 1.24 | 2.21 | 2.42 | 3.91 | 4.90 | 0.008 - 0.622 |
| 3.05 | 120 | 1.49 | 2.66 | 2.91 | 4.70 | 5.89 | 0.009 - 0.747 |
| 3.81 | 150 | 1.87 | 3.32 | 3.64 | 5.88 | 7.36 | 0.012 - 0.933 |
| 5.08 | 200 | 2.49 | 4.43 | 4.86 | 7.85 | 9.83 | 0.015 - 1.245 |
| 6.35 | 250 | 3.11 | 5.54 | 6.09 | 9.83 | 12.29 | 0.019 - 1.556 |
| 7.62 | 300 | 3.73 | 6.64 | 7.31 | 11.80 | 14.75 | 0.023 - 1.867 |

- 1 When optical zoom and Digital Zoom Extender are used together.
- 2 When [EXTENDER RATIO] is set to [80%].
- 3 Only for optical zoom

Unit: feet

| | | | | Optical zoom | | Digital Zoom Extender ¹ | Distance from the center of lens to the image lower end (H) ³ |
|----------------------|--------|-------------|------------|-------------------------|-----------|--|--|
| Throw ratio | | | | 1.09-1.77:1 | | 1.09-2.21:1 ² (Converted Value) | |
| Projected image size | | | | Projection distance (L) | | | |
| Diagonal (SD) | | Height (SH) | Width (SW) | Min. (LW) | Max. (LT) | Max. (LT) | |
| m | inches | | | | | | |
| 0.76 | 30 | 1.21 | 2.17 | 2.30 | 3.77 | 4.72 | 0.007 - 0.610 |
| 1.02 | 40 | 1.64 | 2.92 | 3.12 | 5.09 | 6.40 | 0.010 - 0.820 |
| 1.27 | 50 | 2.03 | 3.64 | 3.90 | 6.36 | 7.97 | 0.013 - 1.020 |
| 1.52 | 60 | 2.43 | 4.36 | 4.69 | 7.64 | 9.58 | 0.016 - 1.220 |
| 1.78 | 70 | 2.85 | 5.09 | 5.54 | 8.96 | 11.22 | 0.016 - 1.430 |
| 2.03 | 80 | 3.25 | 5.81 | 6.33 | 10.24 | 12.83 | 0.020 - 1.631 |
| 2.29 | 90 | 3.67 | 6.56 | 7.15 | 11.55 | 14.47 | 0.023 - 1.841 |
| 2.54 | 100 | 4.07 | 7.25 | 7.94 | 12.83 | 16.08 | 0.026 - 2.041 |
| 3.05 | 120 | 4.89 | 8.73 | 9.55 | 15.42 | 19.32 | 0.030 - 2.451 |
| 3.81 | 150 | 6.14 | 10.89 | 11.94 | 19.29 | 24.15 | 0.039 - 3.061 |
| 5.08 | 200 | 8.17 | 14.53 | 15.94 | 25.75 | 32.25 | 0.049 - 4.085 |
| 6.35 | 250 | 10.20 | 18.18 | 19.98 | 32.25 | 40.32 | 0.062 - 5.105 |
| 7.62 | 300 | 12.24 | 21.78 | 23.98 | 38.71 | 48.39 | 0.075 - 6.125 |

- 1 When optical zoom and Digital Zoom Extender are used together.
- 2 When [EXTENDER RATIO] is set to [80%].
- 3 Only for optical zoom

Screen aspect ratio 4:3

Unit: meters

| | | | | Optical zoom | | Digital Zoom Extender ¹ | Distance from the center of lens to the image lower end (H) ³ |
|----------------------|--------|-------------|------------|-------------------------|-----------|--|--|
| Throw ratio | | | | 1.31-2.12:1 | | 1.31-2.66:1 ² (Converted Value) | |
| Projected image size | | | | Projection distance (L) | | | |
| Diagonal (SD) | | Height (SH) | Width (SW) | Min. (LW) | Max. (LT) | Max. (LT) | |
| m | inches | | | | | | |
| 0.76 | 30 | 0.46 | 0.61 | 0.78 | 1.27 | 1.59 | 0.025 - 0.228 |
| 1.02 | 40 | 0.61 | 0.82 | 1.05 | 1.71 | 2.15 | 0.034 - 0.306 |
| 1.27 | 50 | 0.76 | 1.02 | 1.32 | 2.14 | 2.68 | 0.042 - 0.381 |
| 1.52 | 60 | 0.91 | 1.22 | 1.58 | 2.57 | 3.22 | 0.051 - 0.456 |
| 1.78 | 70 | 1.07 | 1.42 | 1.86 | 3.01 | 3.77 | 0.059 - 0.534 |
| 2.03 | 80 | 1.22 | 1.62 | 2.12 | 3.44 | 4.31 | 0.068 - 0.609 |
| 2.29 | 90 | 1.37 | 1.83 | 2.40 | 3.88 | 4.86 | 0.076 - 0.687 |
| 2.54 | 100 | 1.52 | 2.03 | 2.67 | 4.31 | 5.40 | 0.085 - 0.762 |
| 3.05 | 120 | 1.83 | 2.44 | 3.21 | 5.18 | 6.49 | 0.102 - 0.915 |
| 3.81 | 150 | 2.29 | 3.05 | 4.01 | 6.48 | 8.11 | 0.127 - 1.143 |
| 5.08 | 200 | 3.05 | 4.06 | 5.36 | 8.65 | 10.83 | 0.169 - 1.524 |
| 6.35 | 250 | 3.81 | 5.08 | 6.71 | 10.83 | 13.54 | 0.212 - 1.905 |
| 7.62 | 300 | 4.57 | 6.10 | 8.05 | 13.00 | 16.25 | 0.254 - 2.286 |

- 1 When optical zoom and Digital Zoom Extender are used together.
- 2 When [EXTENDER RATIO] is set to [80%].
- 3 Only for optical zoom

Unit: feet

| | | | | Optical zoom | | Digital Zoom Extender ¹ | Distance from the center of lens to the image lower end (H) ³ |
|----------------------|--------|-------------|------------|-------------------------|-----------|--|--|
| Throw ratio | | | | 1.31-2.12:1 | | 1.31-2.66:1 ² (Converted Value) | |
| Projected image size | | | | Projection distance (L) | | | |
| Diagonal (SD) | | Height (SH) | Width (SW) | Min. (LW) | Max. (LT) | Max. (LT) | |
| m | inches | | | | | | |
| 0.76 | 30 | 1.51 | 2.00 | 2.56 | 4.17 | 5.22 | 0.082 - 0.748 |
| 1.02 | 40 | 2.00 | 2.69 | 3.44 | 5.61 | 7.05 | 0.112 - 1.004 |
| 1.27 | 50 | 2.49 | 3.35 | 4.33 | 7.02 | 8.79 | 0.138 - 1.250 |
| 1.52 | 60 | 2.99 | 4.00 | 5.18 | 8.43 | 10.56 | 0.167 - 1.496 |
| 1.78 | 70 | 3.51 | 4.66 | 6.10 | 9.88 | 12.37 | 0.194 - 1.752 |
| 2.03 | 80 | 4.00 | 5.31 | 6.96 | 11.29 | 14.14 | 0.223 - 1.998 |
| 2.29 | 90 | 4.49 | 6.00 | 7.87 | 12.73 | 15.94 | 0.249 - 2.254 |
| 2.54 | 100 | 4.99 | 6.66 | 8.76 | 14.14 | 17.72 | 0.279 - 2.500 |
| 3.05 | 120 | 6.00 | 8.01 | 10.53 | 16.99 | 21.29 | 0.335 - 3.002 |
| 3.81 | 150 | 7.51 | 10.01 | 13.16 | 21.26 | 26.61 | 0.417 - 3.750 |
| 5.08 | 200 | 10.01 | 13.32 | 17.59 | 28.38 | 35.53 | 0.554 - 5.000 |
| 6.35 | 250 | 12.50 | 16.67 | 22.01 | 35.53 | 44.42 | 0.696 - 6.250 |
| 7.62 | 300 | 14.99 | 20.01 | 26.41 | 42.65 | 53.31 | 0.833 - 7.500 |

- 1 When optical zoom and Digital Zoom Extender are used together.
- 2 When [EXTENDER RATIO] is set to [80%].
- 3 Only for optical zoom

Screen aspect ratio 21:9

Unit: meters

| Throw ratio | | | | Optical zoom | | Digital Zoom Extender ¹ | Distance from the center of lens to the image lower end (H) ³ |
|----------------------|--------|-------------|------------|-------------------------|-----------|------------------------------------|--|
| Projected image size | | | | Projection distance (L) | | | |
| Diagonal (SD) | | Height (SH) | Width (SW) | Min. (LW) | Max. (LT) | Max. (LT) | |
| m | inches | | | | | | |
| 0.76 | 30 | 0.30 | 0.70 | 0.74 | 1.22 | 1.53 | -0.047 - 0.148 |
| 1.02 | 40 | 0.40 | 0.94 | 1.01 | 1.64 | 2.06 | -0.063 - 0.198 |
| 1.27 | 50 | 0.49 | 1.17 | 1.26 | 2.05 | 2.57 | -0.078 - 0.247 |
| 1.52 | 60 | 0.59 | 1.40 | 1.52 | 2.46 | 3.09 | -0.094 - 0.295 |
| 1.78 | 70 | 0.69 | 1.64 | 1.78 | 2.89 | 3.62 | -0.110 - 0.346 |
| 2.03 | 80 | 0.79 | 1.87 | 2.04 | 3.30 | 4.13 | -0.125 - 0.395 |
| 2.29 | 90 | 0.89 | 2.11 | 2.30 | 3.73 | 4.67 | -0.141 - 0.445 |
| 2.54 | 100 | 0.99 | 2.34 | 2.56 | 4.14 | 5.18 | -0.156 - 0.494 |
| 3.05 | 120 | 1.19 | 2.81 | 3.08 | 4.97 | 6.22 | -0.188 - 0.593 |
| 3.81 | 150 | 1.48 | 3.51 | 3.85 | 6.22 | 7.78 | -0.235 - 0.740 |
| 5.08 | 200 | 1.97 | 4.68 | 5.14 | 8.30 | 10.39 | -0.313 - 0.987 |
| 6.35 | 250 | 2.47 | 5.85 | 6.44 | 10.39 | 12.99 | -0.391 - 1.234 |
| 7.62 | 300 | 2.96 | 7.02 | 7.73 | 12.47 | 15.60 | -0.469 - 1.481 |

- 1 When optical zoom and Digital Zoom Extender are used together.
- 2 When [EXTENDER RATIO] is set to [80%].
- 3 Only for optical zoom

Unit: feet

| Throw ratio | | | | Optical zoom | | Digital Zoom Extender ¹ | Distance from the center of lens to the image lower end (H) ³ |
|----------------------|--------|-------------|------------|-------------------------|-----------|------------------------------------|--|
| Projected image size | | | | Projection distance (L) | | | |
| Diagonal (SD) | | Height (SH) | Width (SW) | Min. (LW) | Max. (LT) | Max. (LT) | |
| m | inches | | | | | | |
| 0.76 | 30 | 0.97 | 2.30 | 2.44 | 3.99 | 5.01 | -0.154 - 0.485 |
| 1.02 | 40 | 1.30 | 3.08 | 3.31 | 5.39 | 6.76 | -0.206 - 0.650 |
| 1.27 | 50 | 1.62 | 3.84 | 4.15 | 6.73 | 8.44 | -0.257 - 0.810 |
| 1.52 | 60 | 1.94 | 4.59 | 4.98 | 8.08 | 10.12 | -0.307 - 0.969 |
| 1.78 | 70 | 2.27 | 5.38 | 5.85 | 9.48 | 11.87 | -0.360 - 1.135 |
| 2.03 | 80 | 2.59 | 6.14 | 6.68 | 10.82 | 13.56 | -0.410 - 1.294 |
| 2.29 | 90 | 2.92 | 6.92 | 7.55 | 12.22 | 15.31 | -0.463 - 1.460 |
| 2.54 | 100 | 3.24 | 7.68 | 8.39 | 13.57 | 16.99 | -0.513 - 1.620 |
| 3.05 | 120 | 3.89 | 9.22 | 10.09 | 16.32 | 20.42 | -0.616 - 1.945 |
| 3.81 | 150 | 4.86 | 11.52 | 12.63 | 20.41 | 25.54 | -0.770 - 2.429 |
| 5.08 | 200 | 6.48 | 15.36 | 16.87 | 27.25 | 34.08 | -1.026 - 3.239 |
| 6.35 | 250 | 8.10 | 19.20 | 21.12 | 34.08 | 42.63 | -1.283 - 4.049 |
| 7.62 | 300 | 9.72 | 23.03 | 25.36 | 40.92 | 51.18 | -1.540 - 4.859 |

- 1 When optical zoom and Digital Zoom Extender are used together.
- 2 When [EXTENDER RATIO] is set to [80%].
- 3 Only for optical zoom

Formula for calculating the projection distance

To use a projected image size not listed in this manual, check the projected image size SD (m) and use the respective formula to calculate the value.

The unit of all the formulae is m. (Values obtained by the following calculation formulae contain a slight error.)

When calculating the value using image size designation (value in inches), multiply the value in inches by 0.0254 and substitute it into SD in the formula.

Unit: m

| Aspect ratio | | 16:10 | 16:9 | 4:3 | |
|--------------------------------------|-----------------------|--------------|----------------------------|----------------------------|----------------------------|
| Screen height (SH) | | = 0.530 x SD | = 0.490 x SD | = 0.6 x SD | |
| Screen width (SW) | | = 0.848 x SD | = 0.872 x SD | = 0.8 x SD | |
| Projection distance (L) ¹ | Optical zoom | Min. (LW) | = 0.9371 x SD - 0.0294 | = 0.9632 x SD - 0.0294 | = 1.0609 x SD - 0.0294 |
| | | Max. (LT) | = 1.5103 x SD - 0.0319 | = 1.5523 x SD - 0.0319 | = 1.7098 x SD - 0.0319 |
| | Digital Zoom Extender | Min. (LW) | = 0.9371 x SD / X - 0.0294 | = 0.9632 x SD / X - 0.0294 | = 1.0609 x SD / X - 0.0294 |
| | | Max. (LT) | = 1.5103 x SD / X - 0.0319 | = 1.5523 x SD / X - 0.0319 | = 1.7098 x SD / X - 0.0319 |

| Aspect ratio | | 21:9 | |
|--------------------------------------|-----------------------|--------------|----------------------------|
| Screen height (SH) | | = 0.389 x SD | |
| Screen width (SW) | | = 0.921 x SD | |
| Projection distance (L) ¹ | Optical zoom | Min. (LW) | = 1.0182 x SD - 0.0294 |
| | | Max. (LT) | = 1.6410 x SD - 0.0319 |
| | Digital Zoom Extender | Min. (LW) | = 1.0182 x SD / X - 0.0294 |
| | | Max. (LT) | = 1.6410 x SD / X - 0.0319 |

¹ X in the formulas represents the setting value of [EXTENDER RATIO] (100%=1.00, 99%=0.99, ...).

Note

- The value for L (distance to screen) varies slightly within ±5% depending on the zoom lens characteristics.
- When keystone correction is used, the image is corrected in the direction that reduces its projected size.

Adjustment range by the lens position shift (optical shift)

The projector supports lens shift in horizontal and vertical direction. The following figure shows the lens shift adjustable range in horizontal and vertical direction with reference to the standard projection position.

Following illustration indicates the lens shift range when the projector is installed on desk/floor.

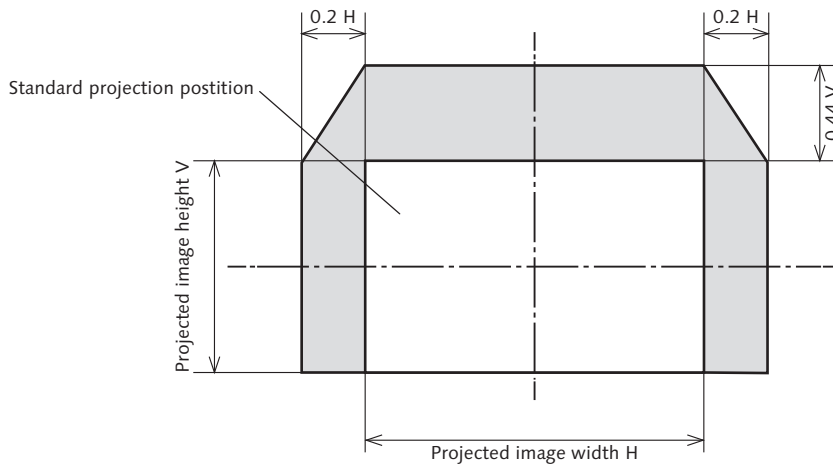

Note

- The standard projection position indicates the projection screen position in the state without lens shift adjustment.

[SCREEN ADJUSTMENT] projection range

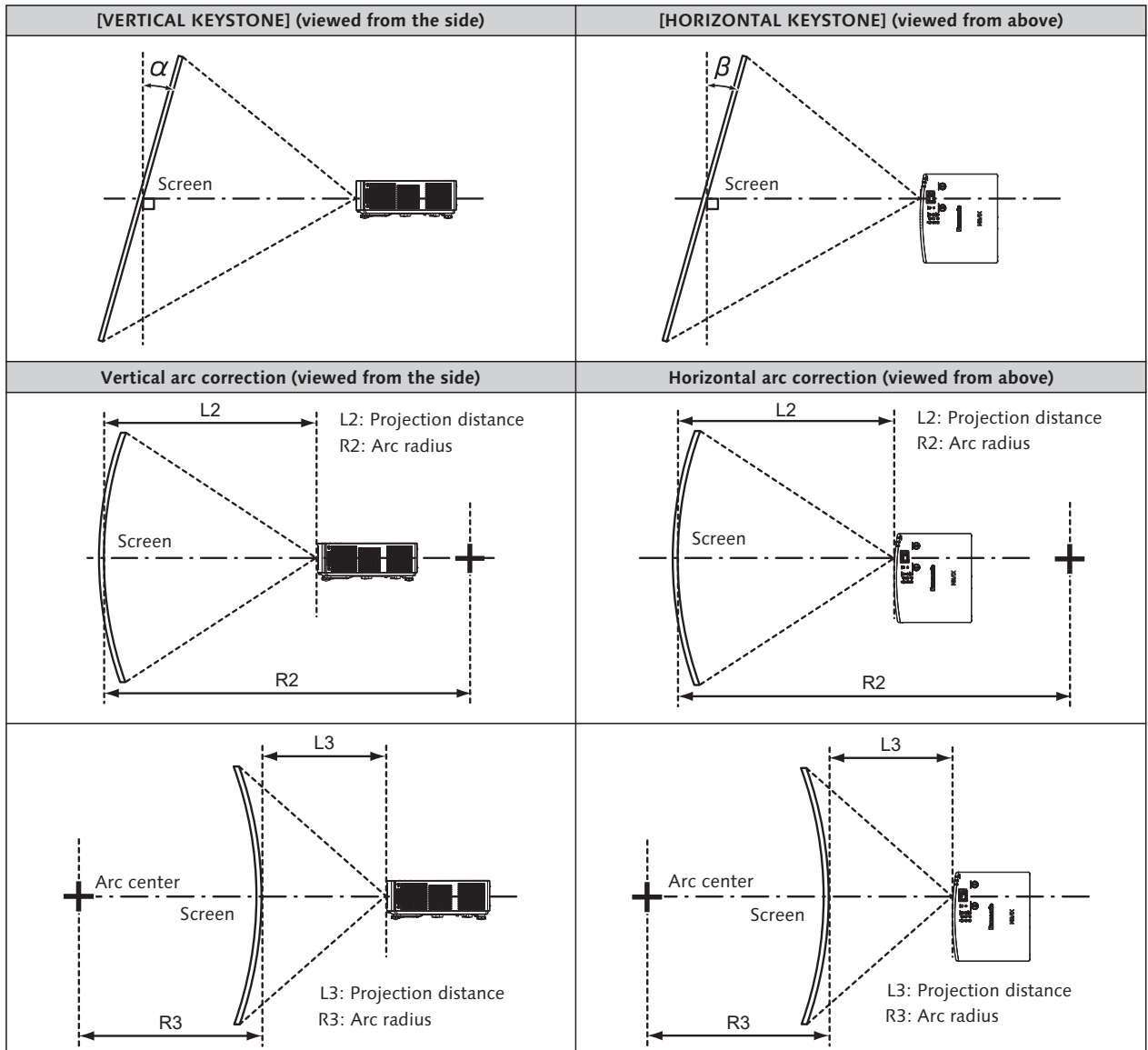

| Model No. | Only [KEYSTONE] used | | Only [CURVED CORRECTION] used | |
|-----------|---|--|-------------------------------|---------------------|
| | Vertical keystone correction angle α (°) | Horizontal keystone correction angle β (°) | Min. value of R2/L2 | Min. value of R3/L3 |
| PT-VMQ65 | ±25 | ±35 | 0.6 | 0.7 |

Note

- When [SCREEN ADJUSTMENT] is used, the focus of the entire screen may be lost as correction increases.
- Make the curved screen a circular arc shape with one part of a perfect circle removed.

Installable angle

Install the projector at an angle within the range shown below.

FULL 360-degree projection

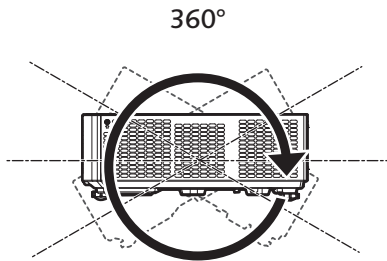

Vertical 360-deg.

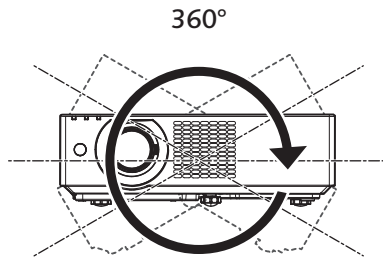

Horizontal 360-deg.

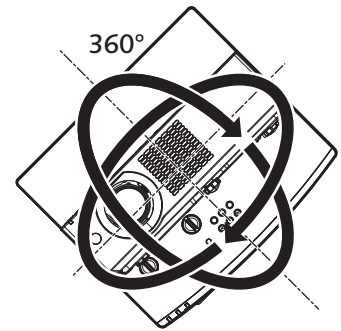

Tilting 360-deg.
(Vertical and Horizontal combination)

Notes on projector placement and operation

- Do not stack projectors on top of each other.
- Do not use the projector supporting it by the top.
- Do not block the intake/exhaust vents of the projector.
- Prevent hot and cool air from the air conditioning system to blow directly to the intake/exhaust vents of the projector.
- Do not install the projector in a confined space.

When installing the projector in a confined space, provide air conditioning or ventilation separately. Exhaust heat may accumulate when the ventilation is not enough, triggering the protection circuit of the projector.

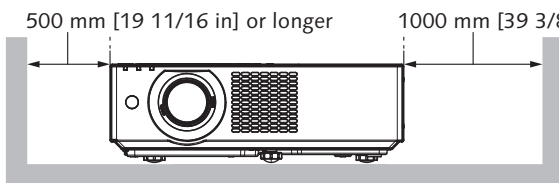
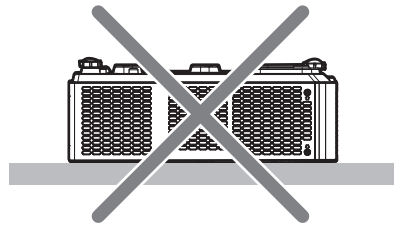
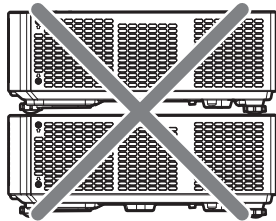

1000 mm [39 3/8 in] or longer

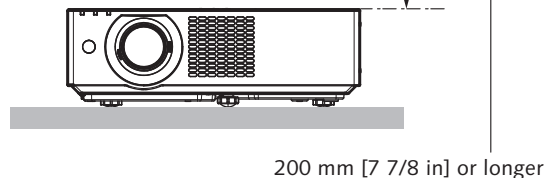
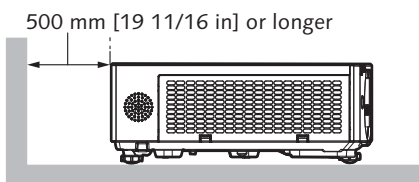
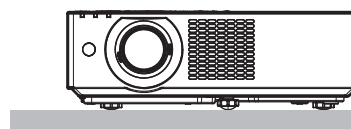

- When installing and fixing the projector on a ceiling or wall using a mount, make sure that the fixing screw or power cord does not come in contact with the metal section inside the ceiling or wall. Failure to observe this may result in electric shocks.
- Panasonic Projector & Display Corporation takes no responsibility for any damage to the product caused by an inappropriate choice of location for installing the projector, even if the warranty period of the product has not expired.
- Immediately remove the product that is not in use anymore by asking a qualified technician.

List of compatible signals

The following table specifies the input image signals that the projector can project.

This projector supports the signal with ✓ in the compatible signal column.

- The content of the signal type column is as follows.

-V: Video signal

-C: Computer signal

| Signal type | Signal name (SIGNAL FORMAT) | Resolution (Dots) | Scanning freq. | | Dot clock freq. (MHz) | Compatible signals | |
|------------------|-----------------------------|-------------------|------------------|-------------------|-----------------------|--------------------|----------------|
| | | | Horizontal (kHz) | Vertical (Hz) | | HDMI™ | DIGITAL LINK |
| V | 480/60p | 720 x 480 | 31.5 | 59.9 | 27.0 | ✓ | ✓ |
| | 576/50p | 720 x 576 | 31.3 | 50.0 | 27.0 | ✓ | ✓ |
| | 720/60p | 1280 x 720 | 45.0 | 60.0 ¹ | 74.3 | ✓ | ✓ |
| | 720/50p | 1280 x 720 | 37.5 | 50.0 | 74.3 | ✓ | ✓ |
| | 1080/60i | 1920 x 1080i | 33.8 | 60.0 ¹ | 74.3 | ✓ | ✓ |
| | 1080/50i | 1920 x 1080i | 28.1 | 50.0 | 74.3 | ✓ | ✓ |
| | 1080/24p | 1920 x 1080 | 27.0 | 24.0 ¹ | 74.3 | ✓ | ✓ |
| | 1080/24sF | 1920 x 1080i | 27.0 | 48.0 ¹ | 74.3 | ✓ | ✓ |
| | 1080/25p | 1920 x 1080 | 28.1 | 25.0 | 74.3 | ✓ | ✓ |
| | 1080/30p | 1920 x 1080 | 33.8 | 30.0 ¹ | 74.3 | ✓ | ✓ |
| | 1080/60p | 1920 x 1080 | 67.5 | 60.0 ¹ | 148.5 | ✓ | ✓ |
| | 1080/50p | 1920 x 1080 | 56.3 | 50.0 | 148.5 | ✓ | ✓ |
| | 1080/120p | 1920 x 1080 | 135.0 | 120.0 | 297.0 | ✓ | ✓ |
| | 3840 x 2160/24p | 3840 x 2160 | 54.0 | 24.0 ¹ | 297.0 | ✓ | ✓ |
| | 3840 x 2160/25p | 3840 x 2160 | 56.3 | 25.0 | 297.0 | ✓ | ✓ |
| | 3840 x 2160/30p | 3840 x 2160 | 67.5 | 30.0 ¹ | 297.0 | ✓ | ✓ |
| | 3840 x 2160/60p | 3840 x 2160 | 135.0 | 60.0 ¹ | 297.0 | ✓ ³ | ✓ ³ |
| | | 3840 x 2160 | 135.0 | 60.0 ¹ | 594.0 | ✓ | — |
| | 3840 x 2160/50p | 3840 x 2160 | 112.5 | 50.0 | 297.0 | ✓ ³ | ✓ ³ |
| | | 3840 x 2160 | 112.5 | 50.0 | 594.0 | ✓ | — |
| | 4096 x 2160/24p | 4096 x 2160 | 54.0 | 24.0 ¹ | 297.0 | ✓ | ✓ |
| | 4096 x 2160/25p | 4096 x 2160 | 56.3 | 25.0 | 297.0 | ✓ | ✓ |
| | 4096 x 2160/30p | 4096 x 2160 | 67.5 | 30.0 ¹ | 297.0 | ✓ | ✓ |
| | 4096 x 2160/60p | 4096 x 2160 | 135.0 | 60.0 ¹ | 297.0 | ✓ ³ | ✓ ³ |
| | | 4096 x 2160 | 135.0 | 60.0 ¹ | 594.0 | ✓ | — |
| | 4096 x 2160/50p | 4096 x 2160 | 112.5 | 50.0 | 297.0 | ✓ ³ | ✓ ³ |
| | | 4096 x 2160 | 112.5 | 50.0 | 594.0 | ✓ | — |
| | C | 640 x 480/60 | 640 x 480 | 31.5 | 59.9 | 25.2 | ✓ |
| 1024 x 768/50 | | 1024 x 768 | 39.6 | 50.0 | 51.9 | ✓ | ✓ |
| 1024 x 768/60 | | 1024 x 768 | 48.4 | 60.0 | 65.0 | ✓ | ✓ |
| 1280 x 800/50 | | 1280 x 800 | 41.3 | 50.0 | 68.0 | ✓ | ✓ |
| 1280 x 800/60 | | 1280 x 800 | 49.7 | 59.8 | 83.5 | ✓ | ✓ |
| 1280 x 1024/50 | | 1280 x 1024 | 52.4 | 50.0 | 88.0 | ✓ | ✓ |
| 1280 x 1024/60 | | 1280 x 1024 | 64.0 | 60.0 | 108.0 | ✓ | ✓ |
| 1366 x 768/50 | | 1366 x 768 | 39.6 | 49.9 | 69.0 | ✓ | ✓ |
| 1366 x 768/60 | | 1366 x 768 | 47.7 | 59.8 | 85.5 | ✓ | ✓ |
| 1400 x 1050/50 | | 1400 x 1050 | 54.1 | 50.0 | 99.9 | ✓ | ✓ |
| 1400 x 1050/60 | | 1400 x 1050 | 65.2 | 60.0 | 122.6 | ✓ | ✓ |
| 1440 x 900/50 | | 1440 x 900 | 46.3 | 49.9 | 86.8 | ✓ | ✓ |
| 1440 x 900/60 | | 1440 x 900 | 55.9 | 59.9 | 106.5 | ✓ | ✓ |
| 1600 x 900/50 | | 1600 x 900 | 46.4 | 49.9 | 96.5 | ✓ | ✓ |
| 1600 x 900/60 | | 1600 x 900 | 55.9 | 60.0 | 119.0 | ✓ | ✓ |
| 1600 x 1200/50 | | 1600 x 1200 | 61.8 | 49.9 | 131.5 | ✓ | ✓ |
| 1600 x 1200/60 | | 1600 x 1200 | 75.0 | 60.0 | 162.0 | ✓ | ✓ |
| 1680 x 1050/50 | | 1680 x 1050 | 54.1 | 50.0 | 119.5 | ✓ | ✓ |
| 1680 x 1050/60 | | 1680 x 1050 | 65.3 | 60.0 | 146.3 | ✓ | ✓ |
| 1920 x 720/60 | | 1920 x 720 | 46.0 | 60.0 | 95.0 | ✓ | ✓ |
| 1920 x 810/60 | 1920 x 810 | 51.7 | 60.0 | 107.0 | ✓ | ✓ | |
| 1920 x 1080/240 | 1920 x 1080 | 270.0 | 240.0 | 594.0 | ✓ | — | |
| 1920 x 1200/50 | 1920 x 1200 | 61.8 | 49.9 | 158.3 | ✓ | ✓ | |
| 1920 x 1200/60RB | 1920 x 1200 ² | 74.0 | 60.0 | 154.0 | ✓ | ✓ | |
| 2048 x 1536/60 | 2048 x 1536 | 95.5 | 60.0 | 267.3 | ✓ | ✓ | |

| Signal type | Signal name (SIGNAL FORMAT) | Resolution (Dots) | Scanning freq. | | Dot clock freq. (MHz) | Compatible signals | |
|-------------|-----------------------------|--------------------------|------------------|---------------|-----------------------|--------------------|--------------|
| | | | Horizontal (kHz) | Vertical (Hz) | | HDMI™ | DIGITAL LINK |
| C | 2560 x 1080/60RB | 2560 x 1080 ² | 66.6 | 60.0 | 176.0 | ✓ | ✓ |
| | 2560 x 1600/60 | 2560 x 1600 ² | 98.7 | 60.0 | 268.5 | ✓ | ✓ |
| | 2560 x 1600/50 | 2560 x 1600 | 82.4 | 50.0 | 286.0 | ✓ | ✓ |
| | 3240 x 1080/60 | 3240 x 1080 | 69.0 | 60.0 | 237.1 | ✓ | ✓ |
| | 3440 x 1440/60 | 3440 x 1440 ² | 88.9 | 60.0 | 312.8 | ✓ | – |
| | 3840 x 2400/30 | 3840 x 2400 ² | 73.0 | 30.0 | 286.2 | ✓ | ✓ |
| | 3840 x 2400/50 | 3840 x 2400 ² | 122.9 | 50.0 | 481.6 | ✓ | – |
| | 3840 x 2400/60 | 3840 x 2400 ² | 148.1 | 60.0 | 592.5 | ✓ | – |

- 1 The signal with 1/1.001x vertical scanning frequency is also supported.
- 2 VESA CVT-RB (Reduced Blanking)-compliant
- 3 YPbPr 4:2:0 format only

Note

- A signal with a different resolution is converted to the number of display dots. The number of display dots is as follows.
 - 3840 x 2400: When [QUAD PIXEL DRIVE] is set to [ON]
 - 1920 x 1200: When [QUAD PIXEL DRIVE] is set to [OFF]
- The "i" at the end of the resolution indicates an interlaced signal.
- When interlaced signals are connected, flickering may occur on the projected image.
- When the DIGITAL LINK connection is made with the long-reach communication method, the signal that the projector can receive is up to 1080/60p (1920 x 1080 dots, dot clock frequency 148.5 MHz).
- Even if it is the signal listed in the list of compatible signals, it may not be displayed by the projector if the image signal is recorded in a special format.

List of plug and play compatible signals

The following table specifies the image signals compatible with plug and play.

Signal with ✓ in the plug and play compatible signal column is the signal described in the EDID (extended display identification data) of the projector. For the signal without ✓ in the plug and play compatible signal column, the resolution may not be selected on the computer even if the projector is supporting it.

- The content of the signal type column is as follows.

-V: Video signal

-C: Computer signal

| Signal type | Signal name (SIGNAL FORMAT) | Resolution (Dots) | Scanning freq. | | Dot clock freq. (MHz) | Plug and play compatible signal | | | | | |
|-------------|-----------------------------|--------------------------|------------------|---------------|-----------------------|---------------------------------|--------|----|----------------|---------------------|----|
| | | | Horizontal (kHz) | Vertical (Hz) | | HDMI™ | | | DIGITAL LINK | | |
| | | | | | | 4K/60p ¹ | 4K/30p | 2K | 4K/60p | 4K/30p ² | 2K |
| V | 480/60p | 720 x 480 | 31.5 | 59.9 | 27.0 | ✓ | ✓ | ✓ | ✓ | ✓ | ✓ |
| | 576/50p | 720 x 576 | 31.3 | 50.0 | 27.0 | ✓ | ✓ | ✓ | ✓ | ✓ | ✓ |
| | 720/60p | 1280 x 720 | 45.0 | 60.0 | 74.3 | ✓ | ✓ | ✓ | ✓ | ✓ | ✓ |
| | 720/50p | 1280 x 720 | 37.5 | 50.0 | 74.3 | ✓ | ✓ | ✓ | ✓ | ✓ | ✓ |
| | 1080/60i | 1920 x 1080i | 33.8 | 60.0 | 74.3 | ✓ | ✓ | ✓ | ✓ | ✓ | ✓ |
| | 1080/50i | 1920 x 1080i | 28.1 | 50.0 | 74.3 | ✓ | ✓ | ✓ | ✓ | ✓ | ✓ |
| | 1080/24p | 1920 x 1080 | 27.0 | 24.0 | 74.3 | ✓ | ✓ | ✓ | ✓ | ✓ | ✓ |
| | 1080/24sF | 1920 x 1080i | 27.0 | 48.0 | 74.3 | – | – | – | – | – | – |
| | 1080/25p | 1920 x 1080 | 28.1 | 25.0 | 74.3 | ✓ | ✓ | ✓ | ✓ | ✓ | ✓ |
| | 1080/30p | 1920 x 1080 | 33.8 | 30.0 | 74.3 | ✓ | ✓ | ✓ | ✓ | ✓ | ✓ |
| | 1080/60p | 1920 x 1080 | 67.5 | 60.0 | 148.5 | ✓ | ✓ | ✓ | ✓ | ✓ | ✓ |
| | 1080/50p | 1920 x 1080 | 56.3 | 50.0 | 148.5 | ✓ | ✓ | ✓ | ✓ | ✓ | ✓ |
| | 1080/120p | 1920 x 1080 | 135.0 | 120.0 | 297.0 | ✓ | ✓ | – | ✓ | ✓ | – |
| | 3840 x 2160/24p | 3840 x 2160 | 54.0 | 24.0 | 297.0 | ✓ | ✓ | – | ✓ | ✓ | – |
| | 3840 x 2160/25p | 3840 x 2160 | 56.3 | 25.0 | 297.0 | ✓ | ✓ | – | ✓ | ✓ | – |
| | 3840 x 2160/30p | 3840 x 2160 | 67.5 | 30.0 | 297.0 | ✓ | ✓ | – | ✓ | ✓ | – |
| | 3840 x 2160/60p | 3840 x 2160 | 135.0 | 60.0 | 297.0 | ✓ ⁴ | – | – | ✓ ⁴ | – | – |
| | | 3840 x 2160 | 135.0 | 60.0 | 594.0 | ✓ | – | – | – | – | – |
| | 3840 x 2160/50p | 3840 x 2160 | 112.5 | 50.0 | 297.0 | ✓ ⁴ | – | – | ✓ ⁴ | – | – |
| | | 3840 x 2160 | 112.5 | 50.0 | 594.0 | ✓ | – | – | – | – | – |
| | 4096 x 2160/24p | 4096 x 2160 | 54.0 | 24.0 | 297.0 | ✓ | ✓ | – | ✓ | ✓ | – |
| | 4096 x 2160/25p | 4096 x 2160 | 56.3 | 25.0 | 297.0 | ✓ | ✓ | – | ✓ | ✓ | – |
| | 4096 x 2160/30p | 4096 x 2160 | 67.5 | 30.0 | 297.0 | ✓ | ✓ | – | ✓ | ✓ | – |
| | 4096 x 2160/60p | 4096 x 2160 | 135.0 | 60.0 | 297.0 | ✓ ⁴ | – | – | ✓ ⁴ | – | – |
| | | 4096 x 2160 | 135.0 | 60.0 | 594.0 | ✓ | – | – | – | – | – |
| | 4096 x 2160/50p | 4096 x 2160 | 112.5 | 50.0 | 297.0 | ✓ ⁴ | – | – | ✓ ⁴ | – | – |
| 4096 x 2160 | | 112.5 | 50.0 | 594.0 | ✓ | – | – | – | – | – | |
| C | 640 x 480/60 | 640 x 480 | 31.5 | 59.9 | 25.2 | ✓ | ✓ | ✓ | ✓ | ✓ | ✓ |
| | 1024 x 768/50 | 1024 x 768 | 39.6 | 50.0 | 51.9 | – | – | – | – | – | – |
| | 1024 x 768/60 | 1024 x 768 | 48.4 | 60.0 | 65.0 | ✓ | ✓ | ✓ | ✓ | ✓ | ✓ |
| | 1280 x 800/50 | 1280 x 800 | 41.3 | 50.0 | 68.0 | – | – | – | – | – | – |
| | 1280 x 800/60 | 1280 x 800 | 49.7 | 59.8 | 83.5 | – | – | – | – | – | – |
| | 1280 x 1024/50 | 1280 x 1024 | 52.4 | 50.0 | 88.0 | – | – | – | – | – | – |
| | 1280 x 1024/60 | 1280 x 1024 | 64.0 | 60.0 | 108.0 | – | – | – | – | – | – |
| | 1366 x 768/50 | 1366 x 768 | 39.6 | 49.9 | 69.0 | – | – | – | – | – | – |
| | 1366 x 768/60 | 1366 x 768 | 47.7 | 59.8 | 85.5 | – | – | – | – | – | – |
| | 1400 x 1050/50 | 1400 x 1050 | 54.1 | 50.0 | 99.9 | – | – | – | – | – | – |
| | 1400 x 1050/60 | 1400 x 1050 | 65.2 | 60.0 | 122.6 | ✓ | ✓ | ✓ | ✓ | ✓ | ✓ |
| | 1440 x 900/50 | 1440 x 900 | 46.3 | 49.9 | 86.8 | – | – | – | – | – | – |
| | 1440 x 900/60 | 1440 x 900 | 55.9 | 59.9 | 106.5 | – | – | – | – | – | – |
| | 1600 x 900/50 | 1600 x 900 | 46.4 | 49.9 | 96.5 | – | – | – | – | – | – |
| | 1600 x 900/60 | 1600 x 900 | 55.9 | 60.0 | 119.0 | ✓ | ✓ | ✓ | ✓ | ✓ | ✓ |
| | 1600 x 1200/50 | 1600 x 1200 | 61.8 | 49.9 | 131.5 | – | – | – | – | – | – |
| | 1600 x 1200/60 | 1600 x 1200 | 75.0 | 60.0 | 162.0 | ✓ | ✓ | ✓ | ✓ | ✓ | ✓ |
| | 1680 x 1050/50 | 1680 x 1050 | 54.1 | 50.0 | 119.5 | – | – | – | – | – | – |
| | 1680 x 1050/60 | 1680 x 1050 | 65.3 | 60.0 | 146.3 | – | – | – | – | – | – |
| | 1920 x 720/60 | 1920 x 720 | 46.0 | 60.0 | 95.0 | – | – | – | – | – | – |
| | 1920 x 810/60 | 1920 x 810 | 51.7 | 60.0 | 107.0 | – | – | – | – | – | – |
| | 1920 x 1080/240 | 1920 x 1080 | 270.0 | 240.0 | 594.0 | ✓ | – | – | – | – | – |
| | 1920 x 1200/50 | 1920 x 1200 | 61.8 | 49.9 | 158.3 | – | – | – | – | – | – |
| | 1920 x 1200/60RB | 1920 x 1200 ³ | 74.0 | 60.0 | 154.0 | ✓ | ✓ | ✓ | ✓ | ✓ | ✓ |

| Signal type | Signal name (SIGNAL FORMAT) | Resolution (Dots) | Scanning freq. | | Dot clock freq. (MHz) | Plug and play compatible signal | | | | | |
|----------------|-----------------------------|--------------------------|------------------|---------------|-----------------------|---------------------------------|--------|----|--------------|---------------------|----|
| | | | Horizontal (kHz) | Vertical (Hz) | | HDMI™ | | | DIGITAL LINK | | |
| | | | | | | 4K/60p ¹ | 4K/30p | 2K | 4K/60p | 4K/30p ² | 2K |
| C | 2048 x 1536/60 | 2048 x 1536 | 95.5 | 60.0 | 267.3 | – | – | – | – | – | – |
| | 2560 x 1080/60RB | 2560 x 1080 ³ | 66.6 | 60.0 | 176.0 | ✓ | ✓ | – | ✓ | ✓ | – |
| | 2560 x 1600/60 | 2560 x 1600 ³ | 98.7 | 60.0 | 268.5 | – | – | – | – | – | – |
| | 2560 x 1600/50 | 2560 x 1600 | 82.4 | 50.0 | 286.0 | – | – | – | – | – | – |
| | 3240 x 1080/60 | 3240 x 1080 | 69.0 | 60.0 | 237.1 | – | – | – | – | – | – |
| | 3440 x 1440/60 | 3440 x 1440 ³ | 88.9 | 60.0 | 312.8 | ✓ | – | – | – | – | – |
| | 3840 x 2400/30 | 3840 x 2400 ³ | 73.0 | 30.0 | 286.2 | – | ✓ | – | ✓ | ✓ | – |
| | 3840 x 2400/50 | 3840 x 2400 ³ | 122.9 | 50.0 | 481.6 | – | – | – | – | – | – |
| 3840 x 2400/60 | 3840 x 2400 ³ | 148.1 | 60.0 | 592.5 | ✓ | – | – | – | – | – | |

1 4K/60p indicates 4K/60p/HDR and 4K/60p/SDR.

2 4K/30p indicates 4K/30p/HDR and 4K/30p/SDR.

3 VESA CVT-RB (Reduced Blanking)-compliant

4 YPbPr 4:2:0 format only